

2 500 LT VERTICAL **HEAVY** TANK

Available in a variety of colours / UV-resistant

FRONT VIEW

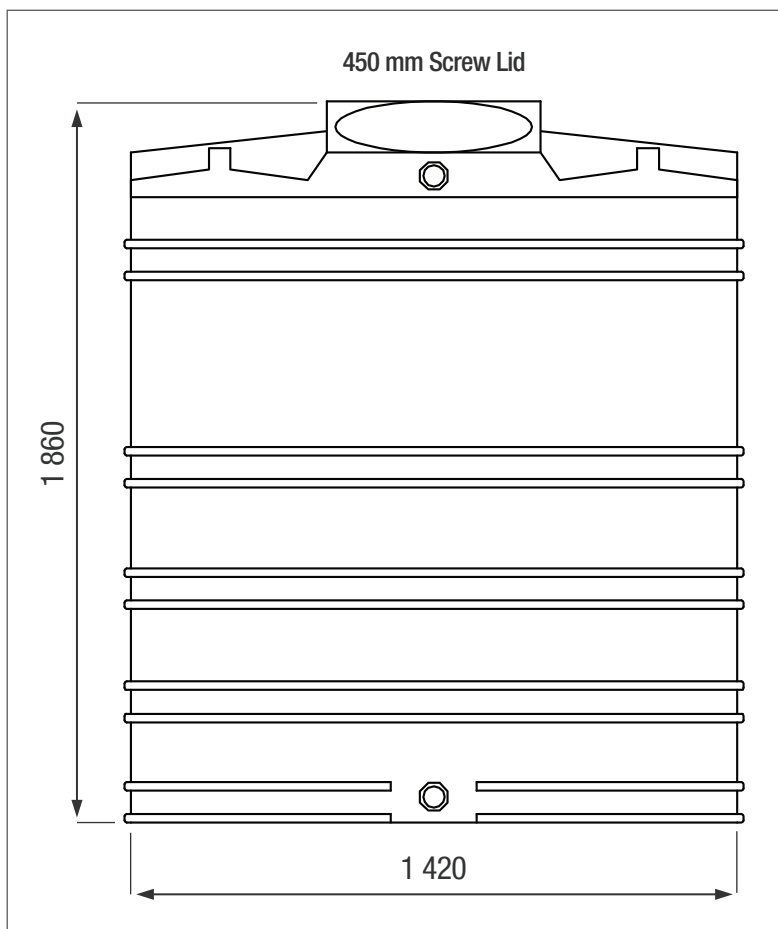

TOP VIEW

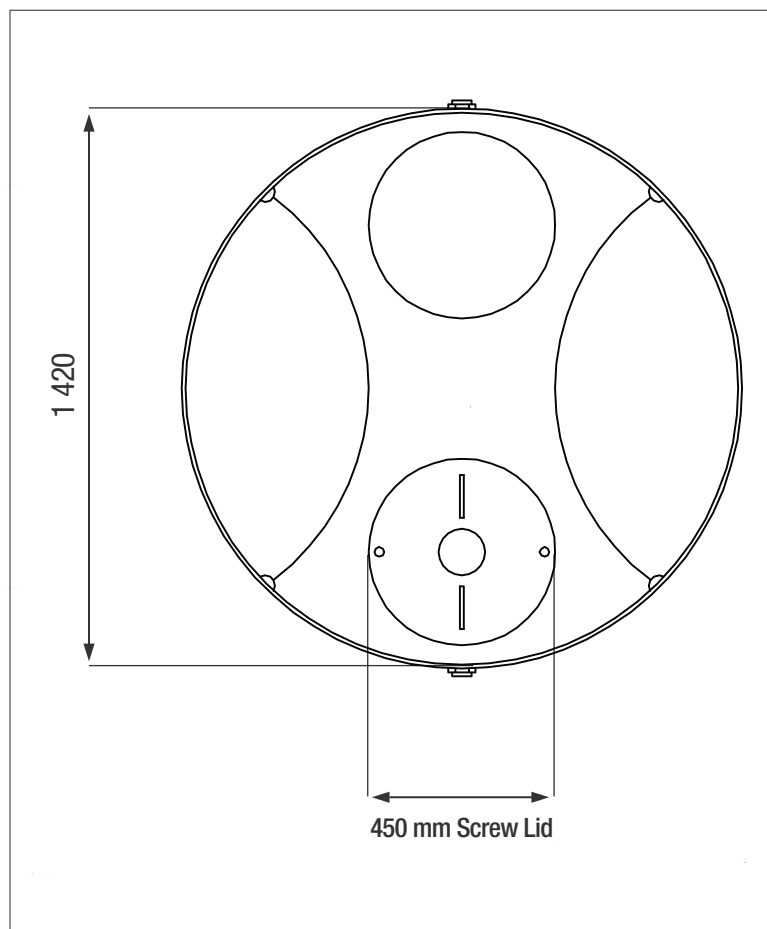

PRODUCT SPECIFICATIONS

Chemical/Heavy	SG 1.6
Outlet	50 mm Connector
Lid	450 mm

ADDITIONAL INFORMATION

* 8 year Guarantee on workmanship

Food Grade LLDPE
BPA Free

ALL DIMENSIONS ARE IN MILLIMETERS
NOTE - SCALE NOT TO SCALE