

2 500 LT CONSERVANCY TANK

Available in black only

SIDE VIEW

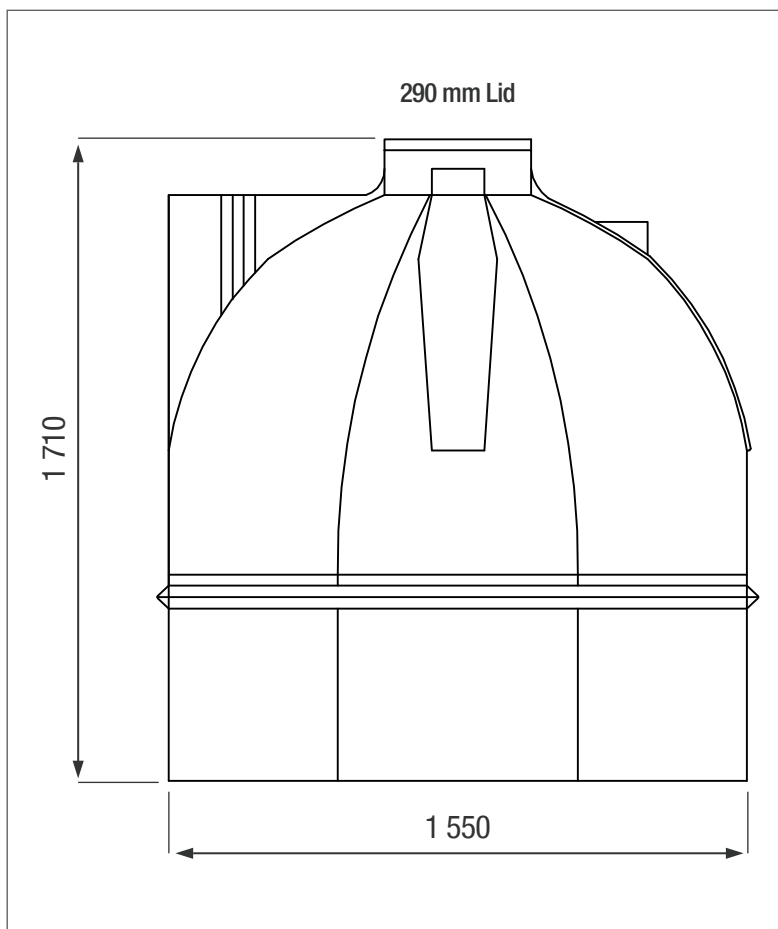

TOP VIEW

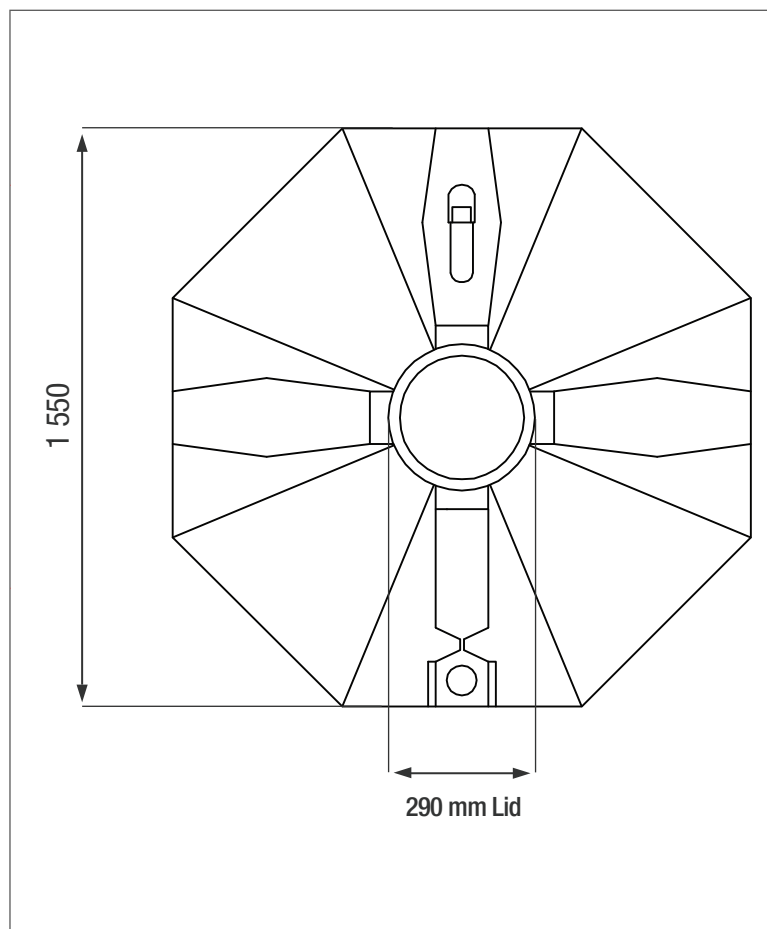

PRODUCT SPECIFICATIONS

- Excluding	Fittings and Holes
Lid	290 mm
To be Pumped Out	

ADDITIONAL INFORMATION

* 8 year Guarantee on workmanship

Food Grade LLDPE
BPA Free

ALL DIMENSIONS ARE IN MILLIMETERS
NOTE - SCALE NOT TO SCALE