

# 20 000 LT VERTICAL WATER TANK

Available in a variety of colours / UV-resistant

FRONT VIEW

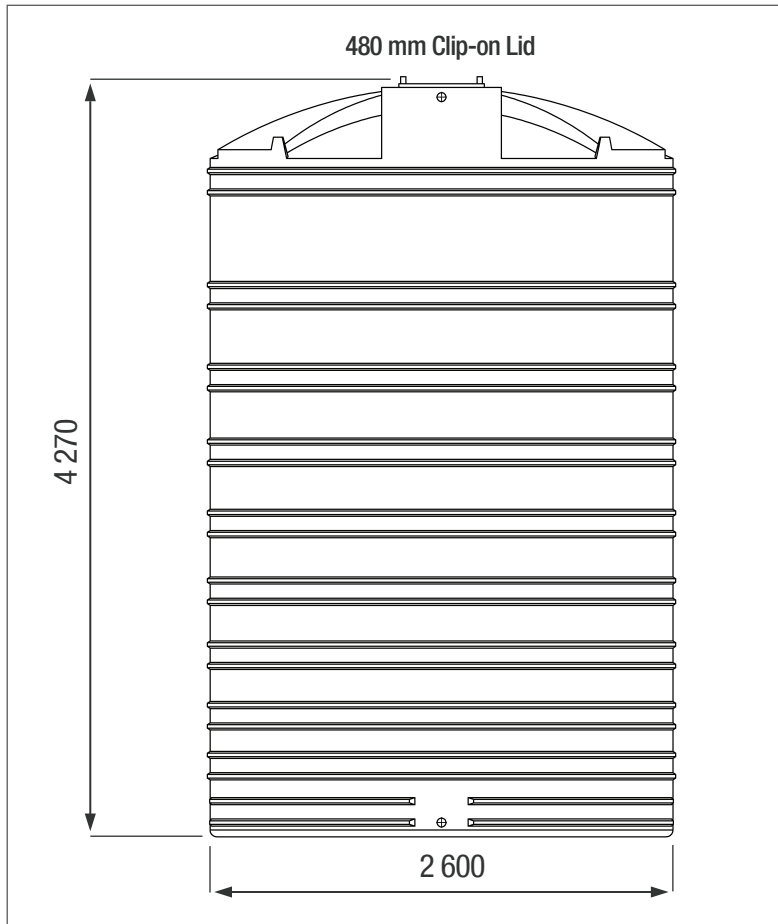

TOP VIEW

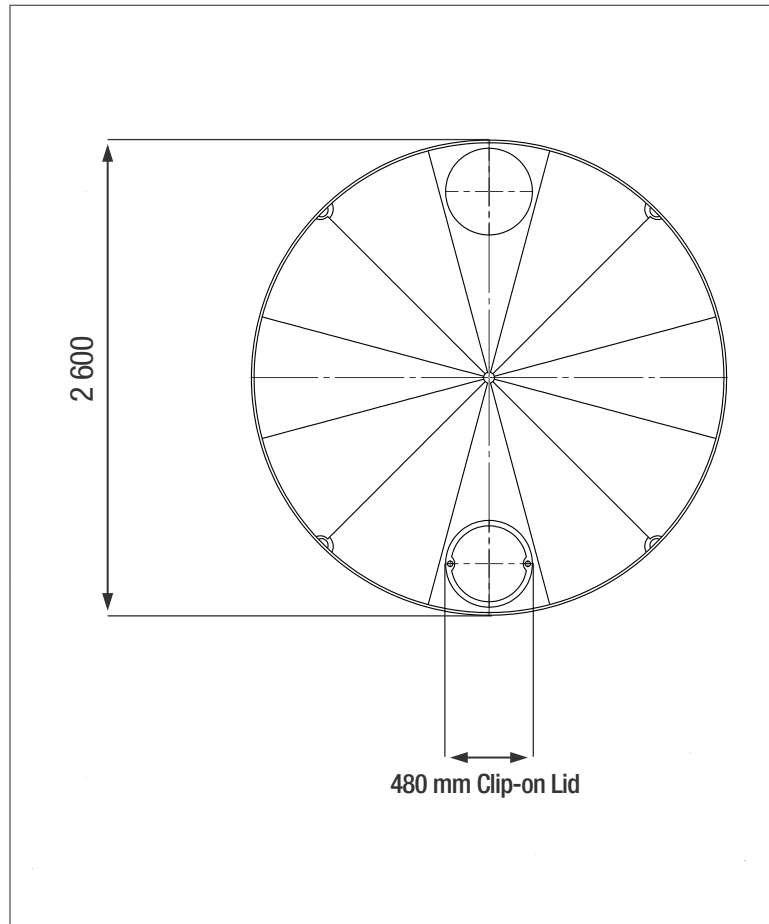

PRODUCT SPECIFICATIONS

Water	SG 1
Inlet	40 mm Female W/Fit
Overflow	40 mm Female W/Fit
Outlet	50 mm Tank Connector
Lid	480 mm

ADDITIONAL INFORMATION

\* 8 year Guarantee on workmanship

**Food Grade LLDPE**  
**BPA Free**

ALL DIMENSIONS ARE IN MILLIMETERS  
NOTE - SCALE NOT TO SCALE