

1 500 LT VERTICAL WATER TANK

Available in a variety of colours / UV-resistant

FRONT VIEW

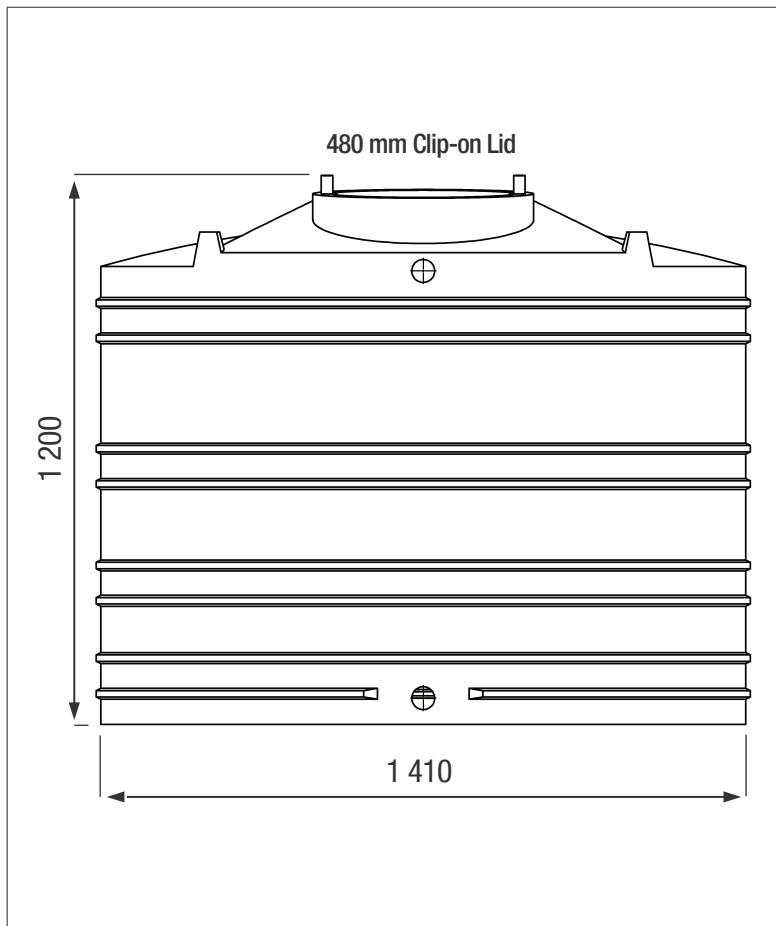

TOP VIEW

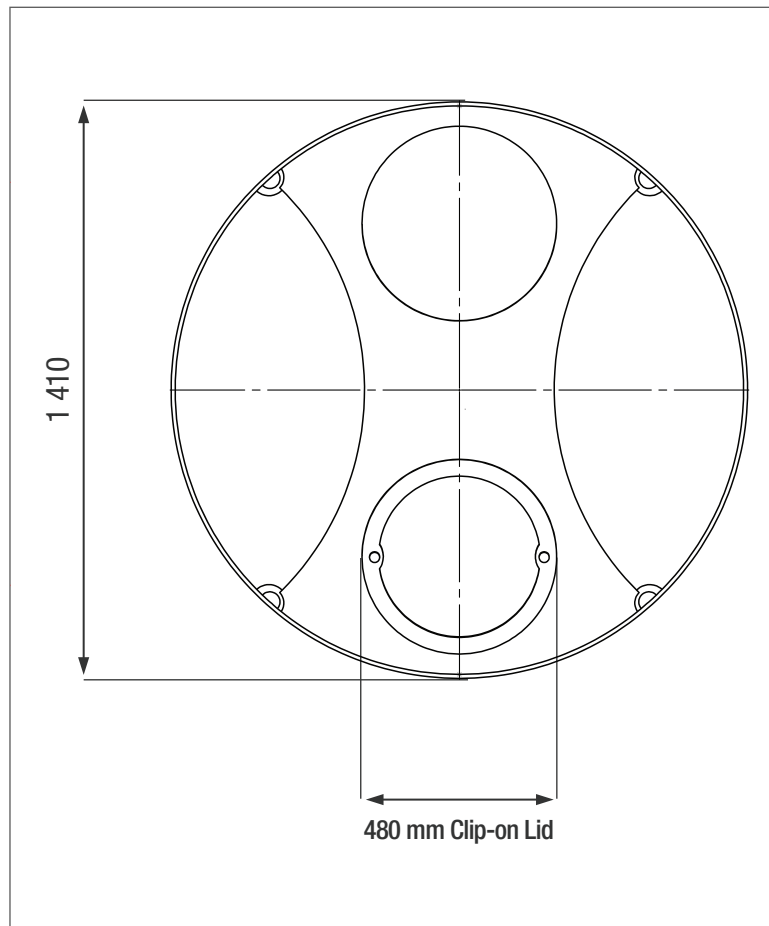

PRODUCT SPECIFICATIONS

Water	SG 1
Inlet	40 mm Female W/Fit
Overflow	40 mm Female W/Fit
Outlet	40 mm Water Fitting
Lid	480 mm

ADDITIONAL INFORMATION

* 8 year Guarantee on workmanship

Food Grade LLDPE
BPA Free

ALL DIMENSIONS ARE IN MILLIMETERS
NOTE - SCALE NOT TO SCALE